

Общий вид с габаритными и присоединительными размерами

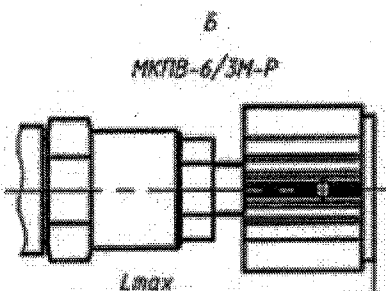

Структура условного обозначения

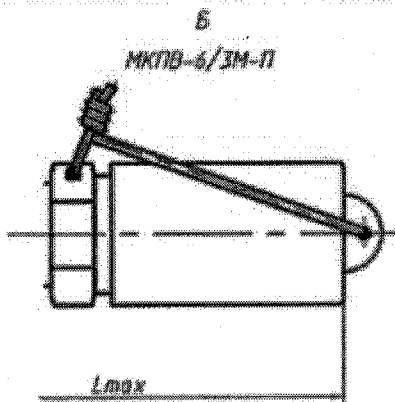
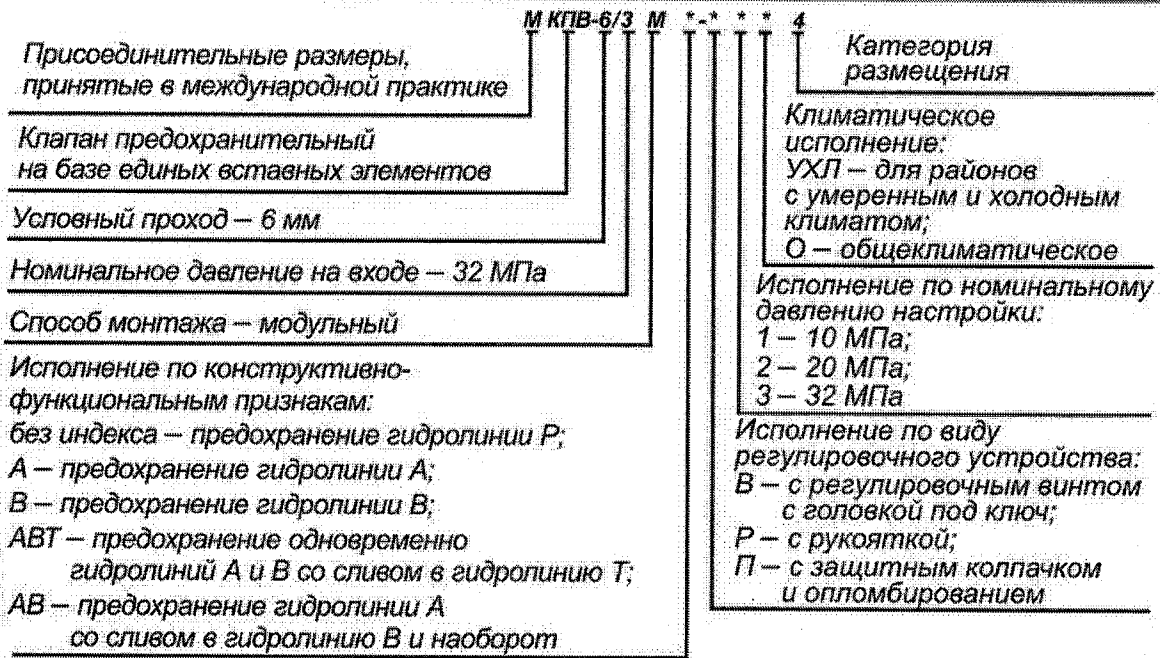

МКГВ-6/3М

МКГВ-6/3МА

МКГВ-6/3МВ

МКГВ-6/3МАВТ

МКГВ-6/3МAB

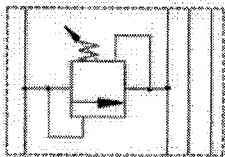

P TAB

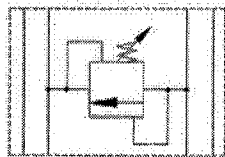

PT AB

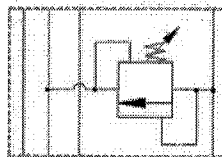

PTA B

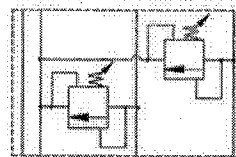

PT A B

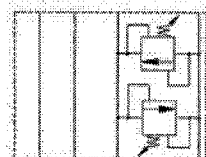

PT A B